

DETALLE: ARMARIO PARA DISTRIBUCIÓN ACOMETIDAS

E. 1/20

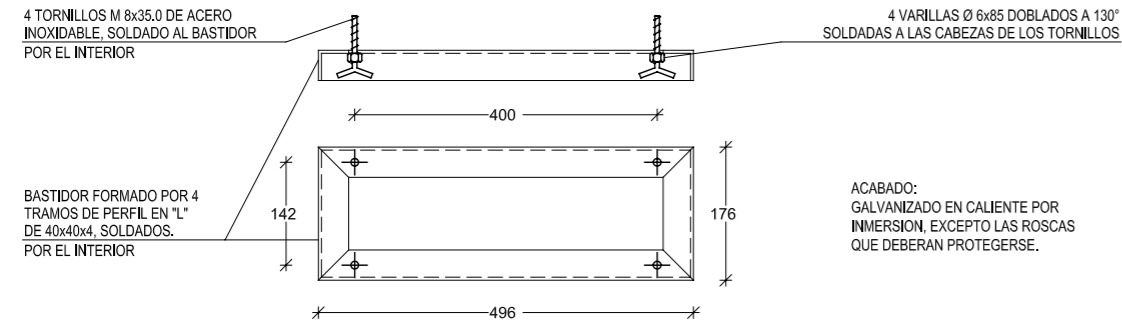
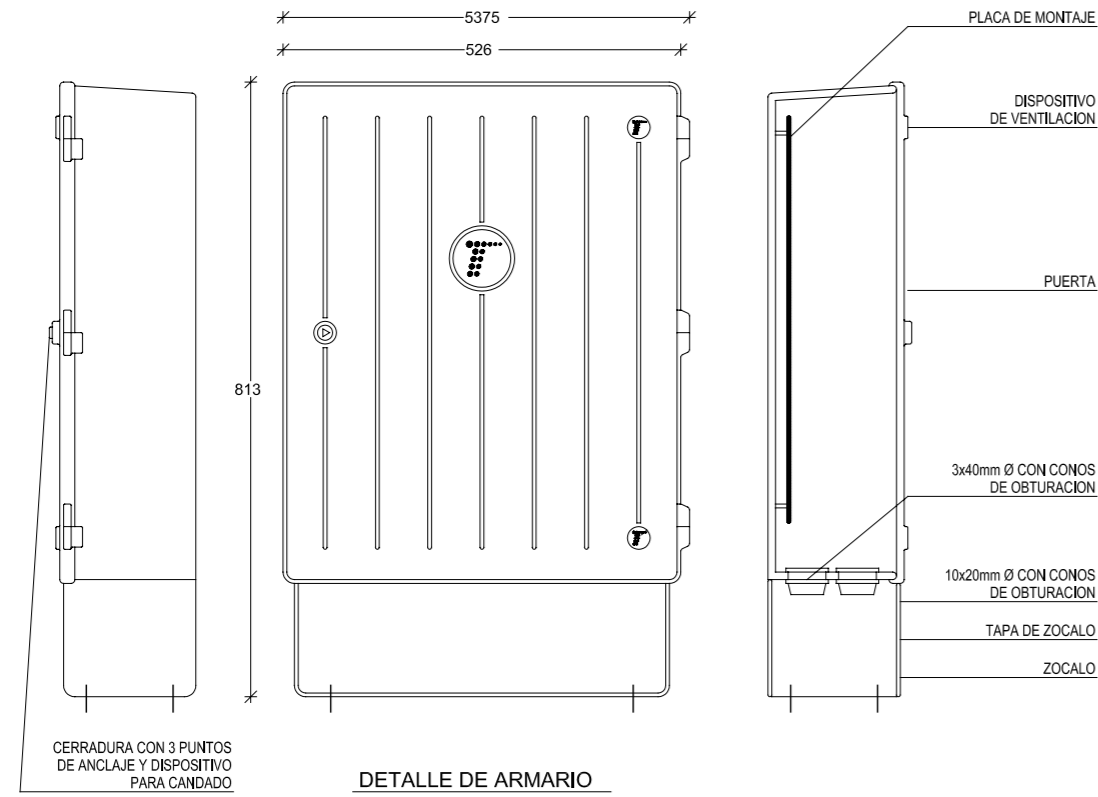

DETALLE: PEDESTAL.

E. 1/20

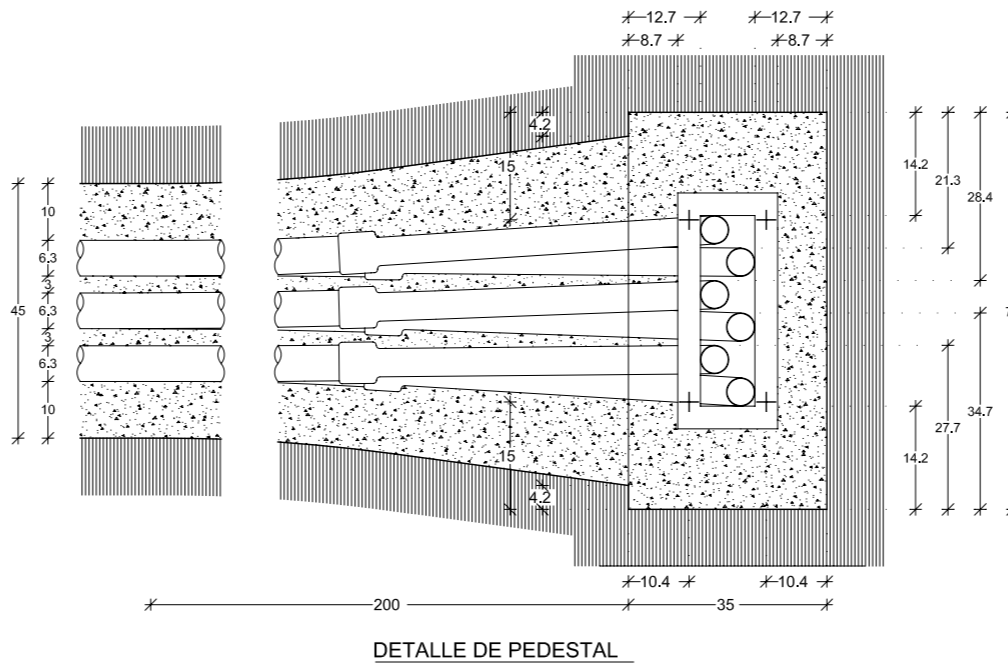
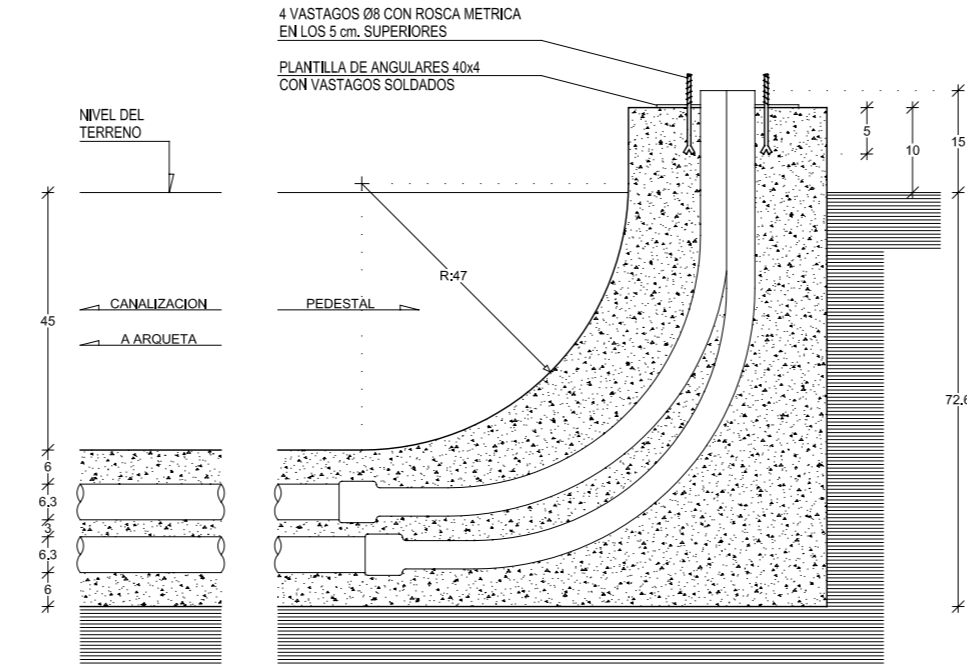

DETALLE: SECCION DE CANALIZACIONES

DETALLE: SECCION CANALIZACION 2c.P.V.C.63Ø

E. 1/20

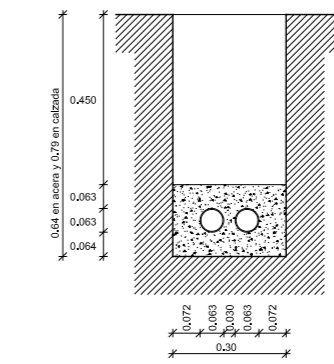

DETALLE: SECCION CANALIZACION 4c.P.V.C.63Ø

E. 1/20

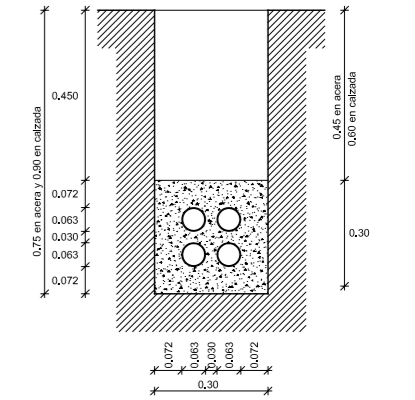

DETALLE: SECCION CANALIZACION 4c.P.V.C.110Ø

E. 1/20

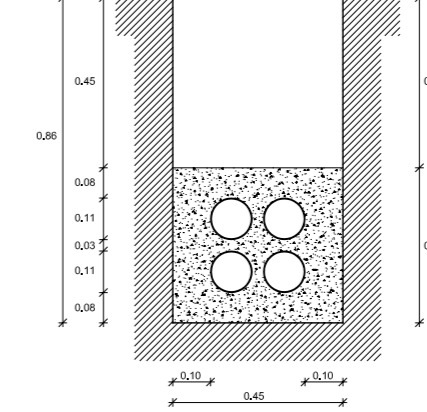

DETALLE: SECCION CANALIZACION 8c.P.V.C.63Ø

E. 1/20

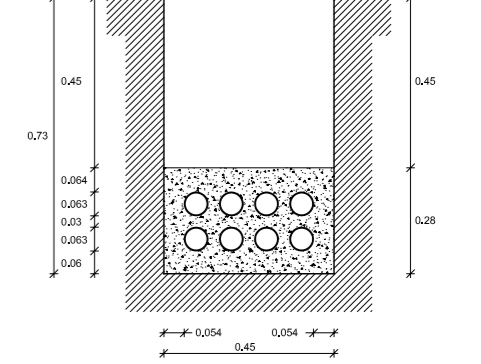

MODIFICADO REFUNDIDO  
PROYECTO DE URBANIZACION DE LA U.E.-3 DEL POLIGONO INDUSTRIAL "EL COLLET" (APROBACION INICIAL 27-07-2009)

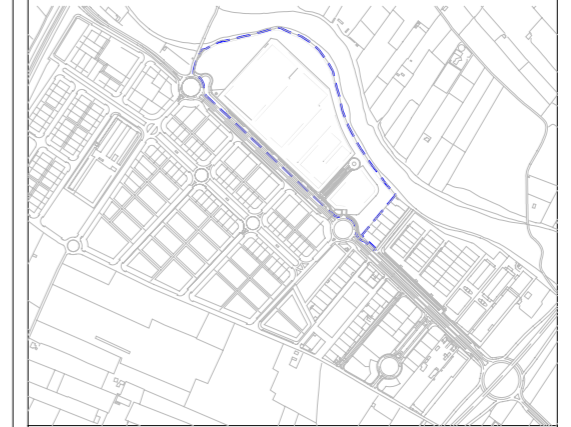

|                |  |
|----------------|--|
| PLANO:         | EMPLAZAMIENTO:   |
| <b>8.1</b>     | U.E.-3 PLAN PACIAL POL. INDUSTRIAL "EL COLLET" BENICARLÓ (CASTELLON) |
|                | PROMOTOR: CAIGOR S.L.  |
| ESCALA: Varias | FECHA: SEPTIEMBRE 2013   |